

HC/ATEX *Wall-mounted axial fans with ATEX certification and possible Ex e, Ex d, Ex tc and Ex tb markings*



HC-25...63



HC-71...100

Wall-mounted axial fans with ATEX certification, with CEE ExII2G Ex e explosion-proof and CEE ExII2G Ex d, Ex tc, or Ex tb flame-resistant motor to work in explosive atmospheres of gas or dust.

Fan:

- Impeller made from cast aluminium
- Airflow direction from motor to impeller
- Stuffing-box spark-proof included
- Protection guard against contacts, in accordance with standard UNE-EN ISO 12499:2010 included in models 25 to 63, other models as accessory.
- Support frame in sheet steel with aluminium strip in the impeller area in accordance with Standard EN-14986:2007

Motor:

- Class F motors with ball bearings and ATEX certification, Ex e explosion-proof and Ex d, Ex tc, or Ex tb flame-resistant
- Three phase, 50Hz, 230/400V motors up to and including 4kW. 400/690V over 4kW
- Fan working temperature: -20°C + 40°C

Ex "e" marked: CEE Ex II 2G Ex e
Ex "d" marked: CEE Ex II 2G Ex d
Ex tc marked: CEE Ex II 3D Ex tc
Ex tb marked: CEE Ex II 2D Ex tb
Notified authority: L.O.M
Identification No: LOM3ATEX0157

Finish:

- Rust retardant finish with ATEX paint, containing no ferrous components, in polyester resin polymerised at 190°C, after phosphate free pre-treatment

On request:

- Built-in motors with PTC
- Special windings for different electrical supplies and frequencies
- ATEX construction for different categories
- Fans with two-speed motor.
- Ex d flame-resistant single-phase motors

Order code

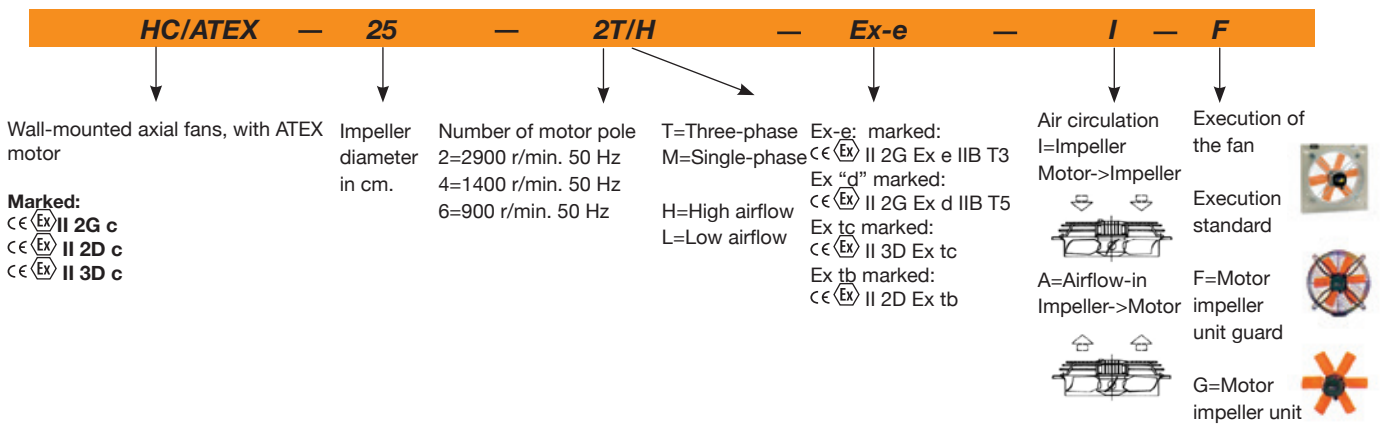

Technical characteristics

Model	Speed (r/min)	Maximum current admissible (A)			Installed power (kW)	Maximum airflow (m³/h)	Sound pressure level dB(A)
		230V	400V	690V			
HC/ATEX-25-2T/H	2730	0.74	0.43		0.12	2200	64
HC/ATEX-25-4T/H	1400	1.28	0.74		0.12	1300	51
HC/ATEX-31-2T/H	2760	1.21	0.70		0.18	3650	72
HC/ATEX-31-4T/H	1400	1.28	0.74		0.12	2400	54
HC/ATEX-31-4T/L	1320	0.65	0.38		0.09	1800	52
HC/ATEX-35-2T/H	2770	2.08	1.20		0.37	6050	76
HC/ATEX-35-4T/H	1400	1.28	0.74		0.12	3550	58
HC/ATEX-35-4T/L	1400	1.28	0.74		0.12	2600	56
HC/ATEX-40-4T/H	1370	2.08	1.20		0.25	5200	63
HC/ATEX-40-4T/L	1400	1.28	0.74		0.12	4050	59
HC/ATEX-40-6T/H	910	2.42	1.40		0.25	3700	55
HC/ATEX-45-4T/H	1370	2.60	1.50		0.37	7300	66
HC/ATEX-45-4T/L	1370	2.08	1.20		0.25	5600	63
HC/ATEX-45-6T/H	910	2.42	1.40		0.25	5150	57
HC/ATEX-50-4T/H	1410	2.94	1.70		0.55	10200	69
HC/ATEX-50-4T/L	1370	2.08	1.20		0.25	7400	66

Technical characteristics

Model	Speed (r/min)	Maximum current admissible (A)			Installed power (kW)	Maximum airflow (m³/h)	Sound pressure level dB(A)
		230V	400V	690V			
HC/ATEX-50-6T/H	935	2.77	1.60		0.37	6300	59
HC/ATEX-56-4T/H	1410	5.20	3.00		1.10	13000	72
HC/ATEX-56-4T/L	1410	2.94	1.70		0.55	11050	70
HC/ATEX-56-6T/H	935	2.77	1.60		0.37	8300	61
HC/ATEX-63-4T/H	1410	5.20	3.00		1.10	16450	74
HC/ATEX-63-4T/L	1410	3.81	2.20		0.75	14400	73
HC/ATEX-63-6T/H	935	2.77	1.60		0.37	12350	64
HC/ATEX-71-4T/H	1400	6.93	4.00		1.50	22150	78
HC/ATEX-71-6T/H	930	4.16	2.40		0.75	17300	66
HC/ATEX-80-4T/H	1440	12.30	7.10		3.00	33000	82
HC/ATEX-80-4T/L	1400	6.93	4.00		1.50	25000	79
HC/ATEX-80-6T/H	930	4.16	2.40		0.75	22000	71
HC/ATEX-80-6T/L	930	3.46	2.00		0.55	19200	70
HC/ATEX-90-4T/H	1450	15.76	9.10		4.00	43700	86
HC/ATEX-90-4T/L	1440	12.30	7.10		3.00	33700	83
HC/ATEX-90-6T/H	940	7.62	4.40		1.50	33300	76
HC/ATEX-90-6T/L	910	5.89	3.40		1.10	26550	73
HC/ATEX-100-4T/H	1440		12.00	6.93	5.50	54000	88
HC/ATEX-100-4T/L	1450	15.76	9.10		4.00	42750	84
HC/ATEX-100-6T/H	940	7.62	4.40		1.50	37000	78
HC/ATEX-100-6T/L	910	5.89	3.40		1.10	29000	76

Dimensions in mm

HC/ATEX 25...63

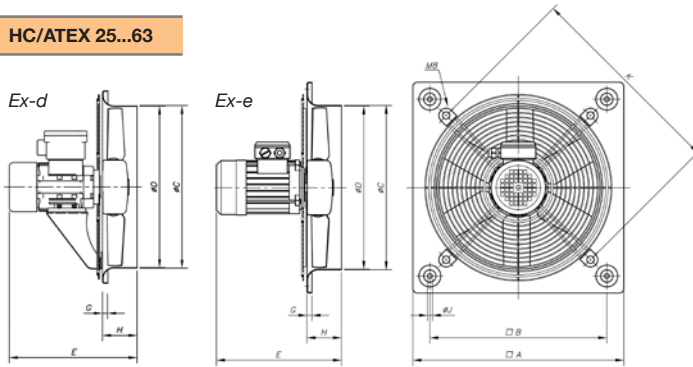

HC/ATEX 71...100

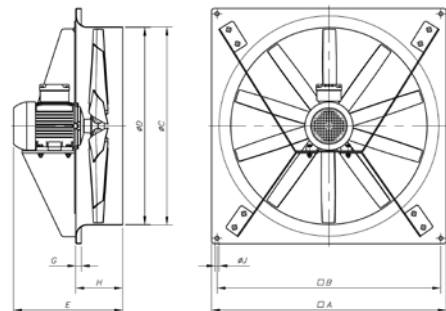

Model	∅A	∅B	∅C	∅D	E	G	H	∅J	K
HC-25	330	275	262	260	236.5	11	56	8.5	310
HC-31-2	400	336	310.5	308	264.5	11	65	10.5	380
HC-31-4	400	336	310.5	308	245.5	11	65	10.5	380
HC-35-2	465	390	362.5	360	275.5	11	76	10.5	450
HC-35-4	465	390	362.5	360	256.5	11	76	10.5	450
HC-40-4.../H	532	452	412.5	410	297.5	11	97.5	10.5	500
HC-40-4.../L	532	452	412.5	410	278.5	11	97.5	10.5	500
HC-40-6.../H	532	452	412.5	410	308.5	11	97.5	10.5	500
HC-45-4.../H	596	504	462.5	460	315.5	11	105	10.5	560
HC-45-4.../L	596	504	462.5	460	304.5	11	105	10.5	560
HC-45-6.../H	596	504	462.5	460	315.5	11	105	10.5	560
HC-50-4T/H	665	562	516.5	514	325.5	11	115	10.5	640
HC-50-4.../L	665	562	516.5	514	283.5	11	115	10.5	640
HC-50-6.../H	665	562	516.5	514	351	11	115	10.5	640
HC-56-4T/H	710	630	563	560	374	15	115	10.5	721
HC-56-4T/L	710	630	563	560	325.5	15	115	10.5	721
HC-56-6.../H	710	630	563	560	351	15	115	10.5	721
HC-63-4T/H	800	710	638	635	399	15	140	10.5	820
HC-63-4.../L	800	710	638	635	376	15	140	10.5	820
HC-63-6.../H	800	710	638	635	376	15	140	10.5	820

The measures correspond to the Ex "e" version

Model	∅A	∅B	∅C	∅D	E	G	H	∅J
HC-71-4T/H	850	810	715	711	395	20	170	14.5
HC-71-6T/H	850	810	715	711	395	20	170	14.5
HC-80-4T/H	970	910	801	797	488	20	210	14.5
HC-80-4T/L	970	910	801	797	458	20	210	14.5
HC-80-6T/H	970	910	801	797	458	20	210	14.5
HC-80-6T/L	970	910	801	797	416	20	210	14.5
HC-90-4T/H	1170	1110	918	914	511	20	210	14.5
HC-90-4T/L	1170	1110	918	914	488	20	210	14.5
HC-90-6T/H	1170	1110	918	914	488	20	210	14.5
HC-90-6T/L	1170	1110	918	914	455	20	210	14.5
HC-100-4T/H	1170	1110	1003	999	548	20	220	14.5
HC-100-4T/L	1170	1110	1003	999	521	20	220	14.5
HC-100-6T/H	1170	1110	1003	999	498	20	220	14.5
HC-100-6T/L	1170	1110	1003	999	468	20	220	14.5

The measures correspond to the Ex "e" version

Acoustic features

The specified values are determined according to free field measurements of pressure and sound levels in dB(A) at an equivalent distance of twice the fan's span plus the impeller's diameter, with a minimum of 1.5 m.

Sound power Lw(A) spectrum in dB(A) via frequency band in Hz.

Model	63	125	250	500	1000	2000	4000	8000	Model	63	125	250	500	1000	2000	4000	8000
25-2/H	38	48	65	65	73	69	62	53	56-4/L	43	58	68	73	79	80	76	69
25-4/H	25	35	52	52	60	56	49	40	63-4/H	43	60	73	80	85	86	81	74
31-2/H	46	56	73	73	81	77	70	61	63-6/H	33	50	63	70	75	76	71	64
31-4/H	28	38	55	55	63	59	52	43	63-4/L	48	63	73	78	84	85	81	74
31-4/L	26	36	53	53	61	57	50	41	71-4/H	47	64	77	84	89	90	85	78
35-2/H	50	60	77	77	85	81	74	65	71-6T/H	35	52	65	72	77	78	73	66
35-4/H	32	42	59	59	67	63	56	47	80-4/H	60	81	88	93	96	92	85	74
35-4/L	30	40	57	57	65	61	54	45	80-6/H	49	70	77	82	85	81	74	63
40-4/H	28	45	57	65	70	70	66	59	80-4/L	57	78	85	90	93	89	82	71
40-4/L	29	45	55	59	66	66	62	55	80-6/L	48	69	76	81	84	80	73	62
40-6/H	20	37	49	57	62	62	58	51	90-4/H	64	85	92	97	100	96	89	78
45-4/H	33	50	63	70	75	76	71	64	90-6/H	54	75	82	87	90	86	79	68
45-4/L	36	51	61	66	72	73	69	62	90-4/L	61	82	89	94	97	93	86	75
45-6/H	24	41	54	61	66	67	62	55	90-6/L	51	72	79	84	87	83	76	65
50-4/H	36	53	66	73	78	79	74	67	100-4/H	68	88	96	101	103	100	93	82
50-4/L	39	54	64	69	75	76	72	65	100-6/H	58	78	86	91	93	90	83	72
50-6/H	26	43	56	63	68	69	64	57	100-4/L	64	84	92	97	99	96	89	78
56-4/H	39	56	69	76	81	82	77	70	100-6/L	56	76	84	89	91	88	81	70
56-6/H	28	45	58	65	70	71	66	59									

Characteristic curves

Q = Airflow in m³/h, m³/s and cfm.

Pe = Static pressure in mmH₂O, Pa and inwg.

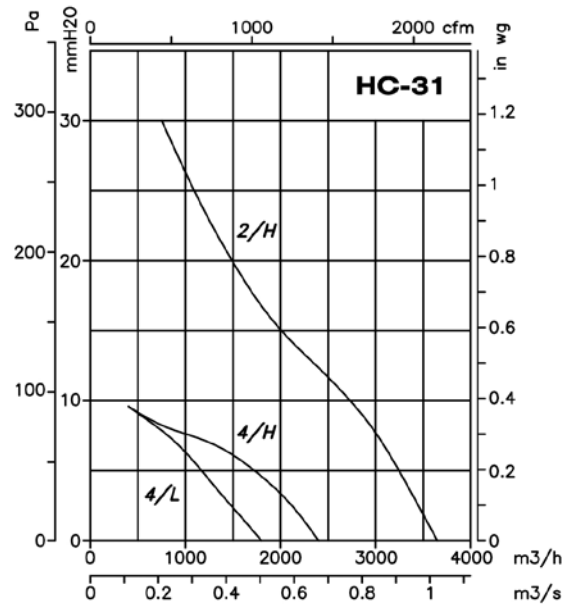
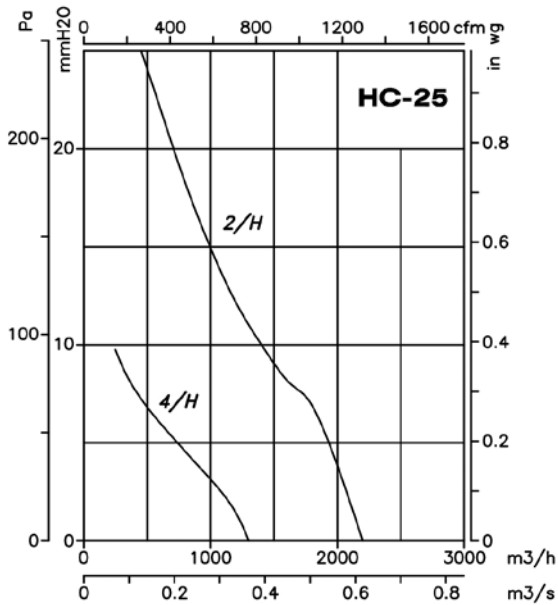

Characteristic curves

Q = Airflow in m³/h, m³/s and cfm.

Pe = Static pressure in mmH₂O, Pa and inwg.

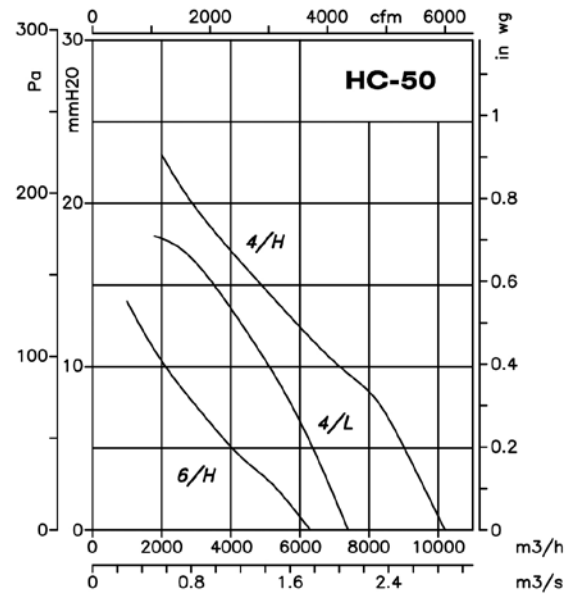
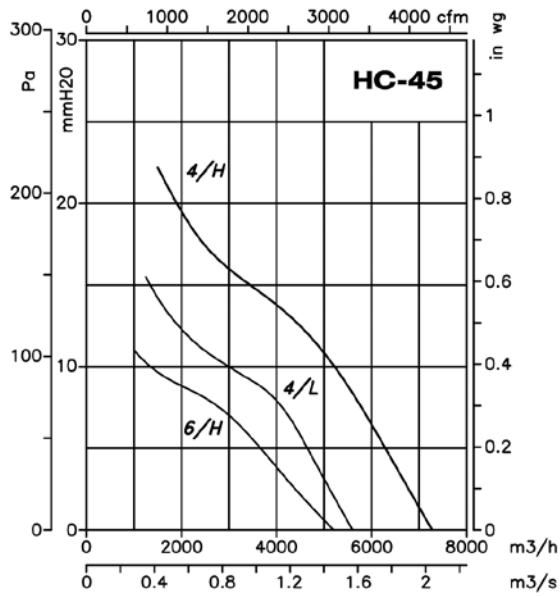
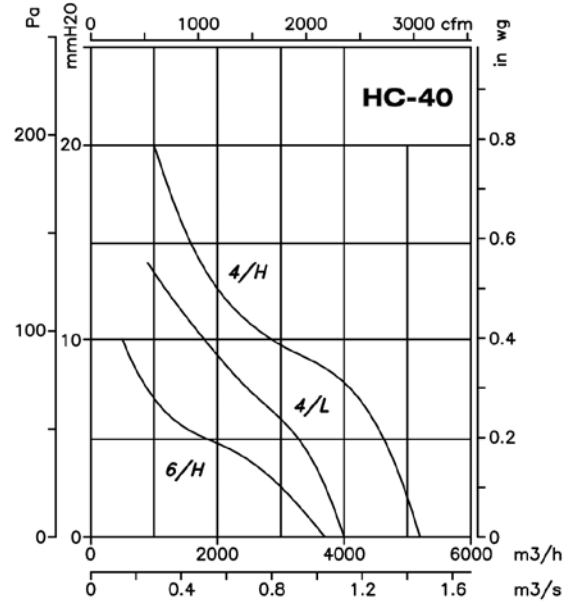
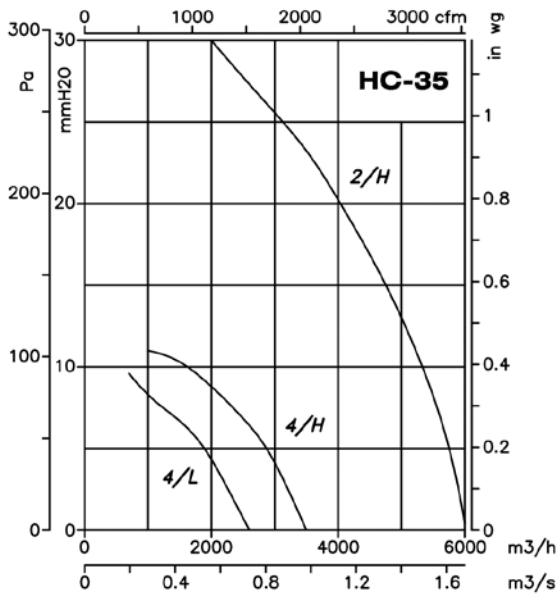

Characteristic curves

Q = Airflow in m³/h, m³/s and cfm.

Pe = Static pressure in mmH₂O, Pa and inwg.

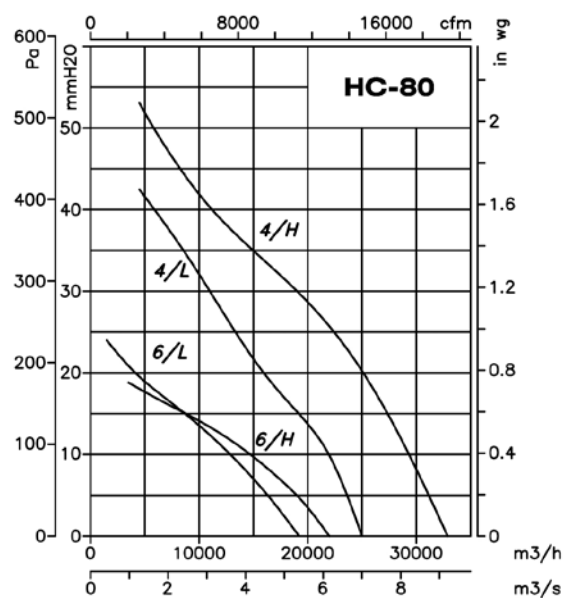
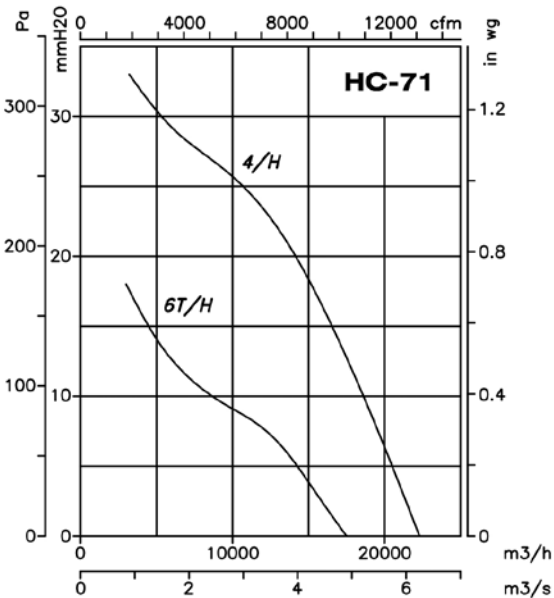
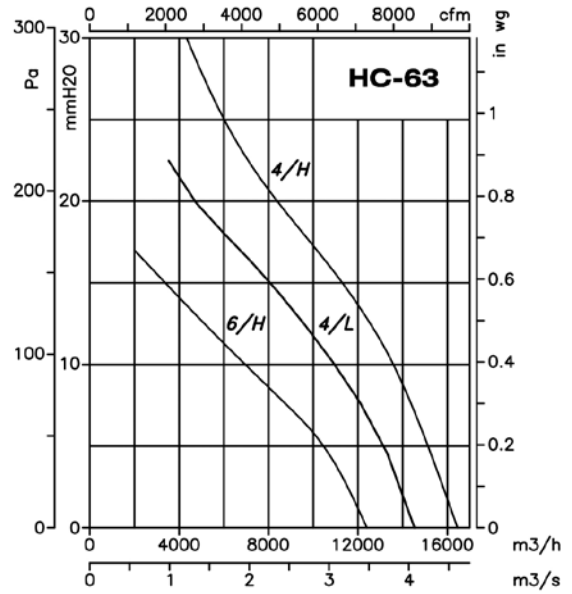
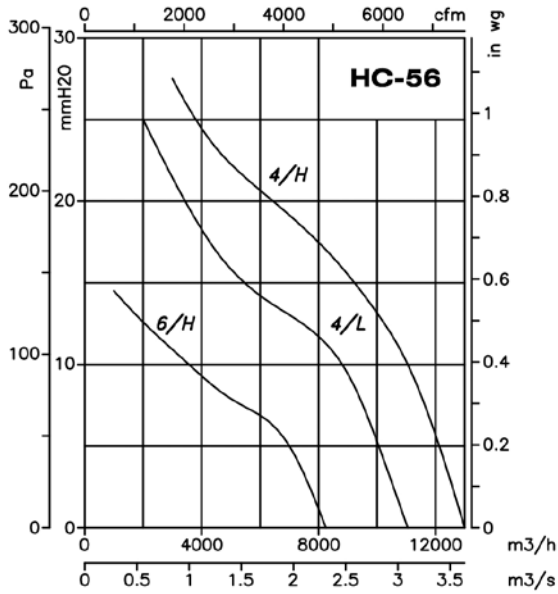

Characteristic curves

Q = Airflow in m³/h, m³/s and cfm.

Pe = Static pressure in mmH₂O, Pa and inwg.

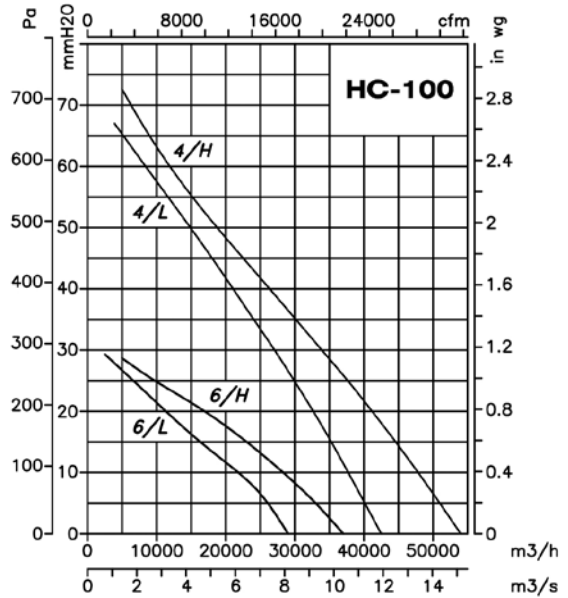
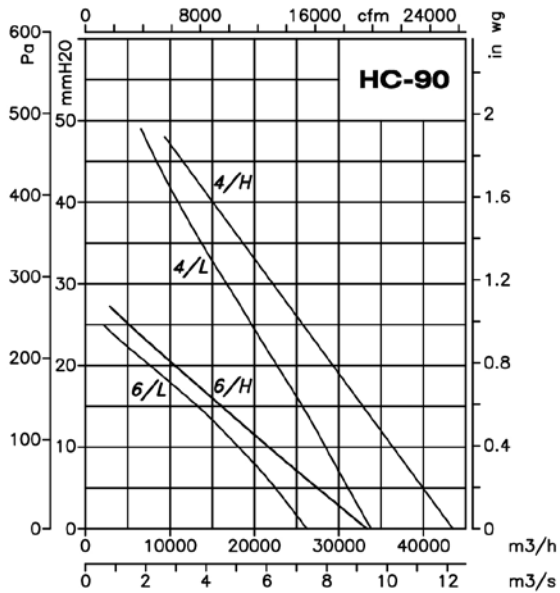

Accessories

See accessories section.

