



Counterflow plate heat recovery exchanger



BASIC FEATURES

WHISPER AIR

Highly efficient wall mounted heat recovery unit designed for ductless installations and decentralised ventilation of **classrooms, offices, conference rooms**.

- 3 sizes with air flow: 400, 700 and 1000 m3/h

- Ecodesign directive 1253/2014 compliant
- Silent operation – **33dB / 35dB** acoustic pressure @ 1m distance
- Heat recovery efficiency up to 93% (EN308) with sensible counter-flow aluminium exchanger
- Humidity recovery up to 85% (EN308) with enthalpy counter-flow exchanger
- Double skin sandwich panel and extra inner insulation – **50mm thickness**
- **Straw-System** and smart labyrinths for optimised laminar airflow
- Energy-efficient EC fans with low SFP
- Choice of horizontal version (horizontal connections for supply and exhaust) and upper versions (horizontal top connections for supply and exhaust)
- Boost function (+25% over nominal airflow)
- **Pre-heater** electric integrated (option)
- **Post-heater** electric, water or change-over integrated (option)
- **AirGENIO Superior** control system with an option of CAV or DCV mode, supplementary modes (timer, anti-freeze protection, etc.), integrated CO2 sensor, touch-screen control panel, BMS control via ModBUS RTU, Modbus TCP or BACnet.

WHISPER AIR heat recovery unit is designed to be operated in a dry indoor environment (relative humidity not exceeding 80%) and at an ambient temperature in the range from +5°C up to +40°C. The unit is designed for transporting standard atmospheric air that is free of dust, grease, chemical emissions and other impurities. The transported air relative humidity must not exceed 90%. The casing of the unit is made from sandwich panels. When unit installed its IP rating is 20. The design of the ventilation project must be **always designed by a qualified HVAC designer, engineer or architect**.

MAIN PARTS

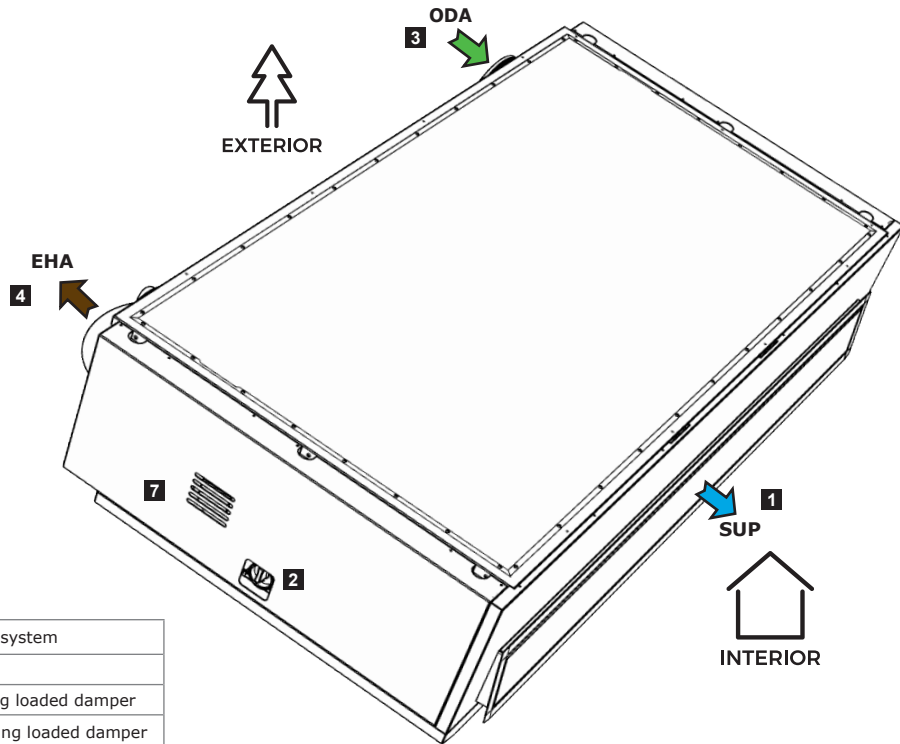

1	Outlet grill with Straw system
2	Main switch
3	Outside fresh air duct with spring loaded damper
4	Outside exhaust air duct with spring loaded damper
5	Inlet grill with Straw system
6	Condensate drain
7	CO ₂ sensor

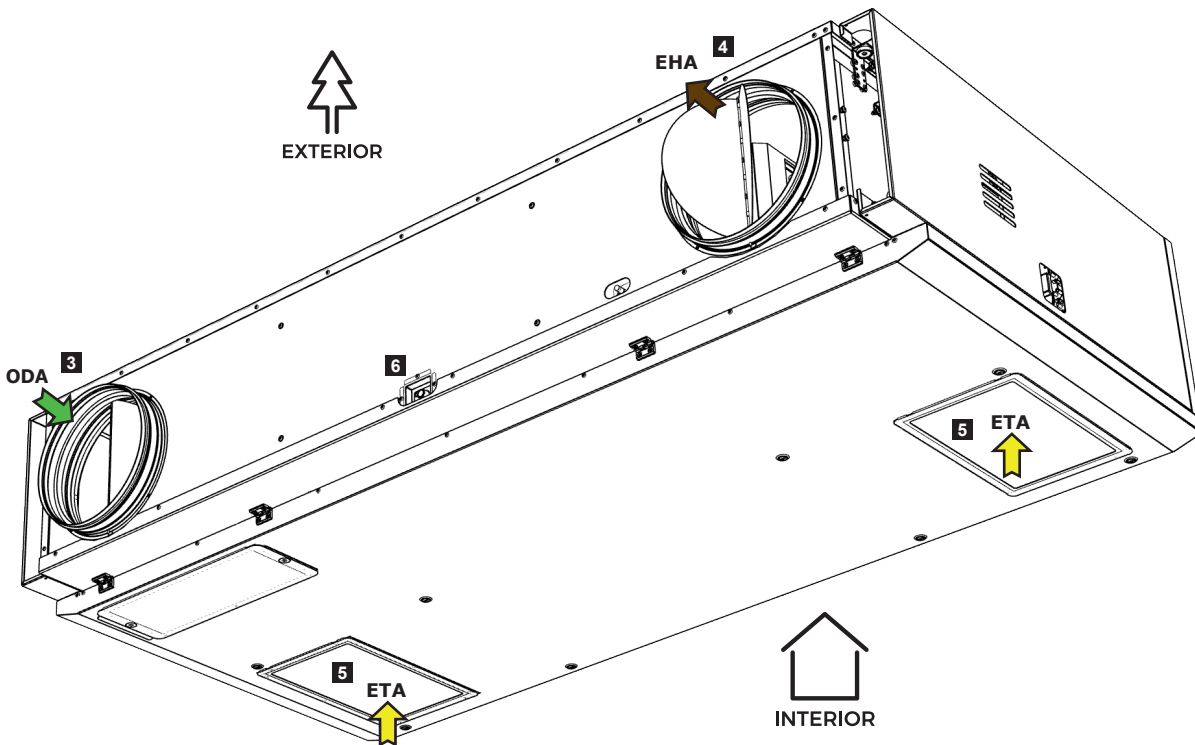

Operational diagram

1	Fan
2	Filter
3	Preheater
4	Afterheater
5	Condensate drain
6	Heat exchanger with by-pass damper
7	Straw-System

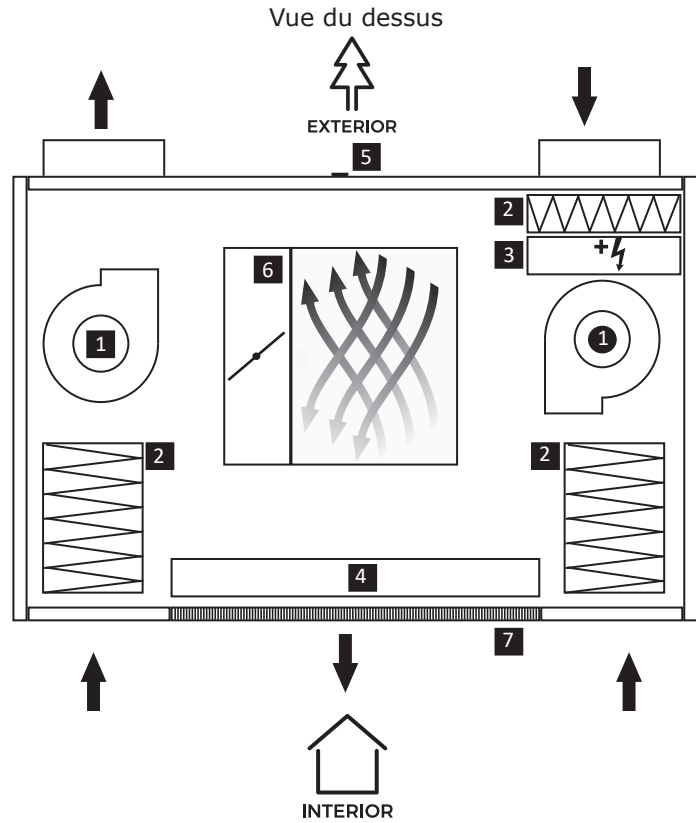

PRIMARY PARAMETERS

SFP=Unit Power input/supply airflow (kW/m³/s)

HRWA3-400

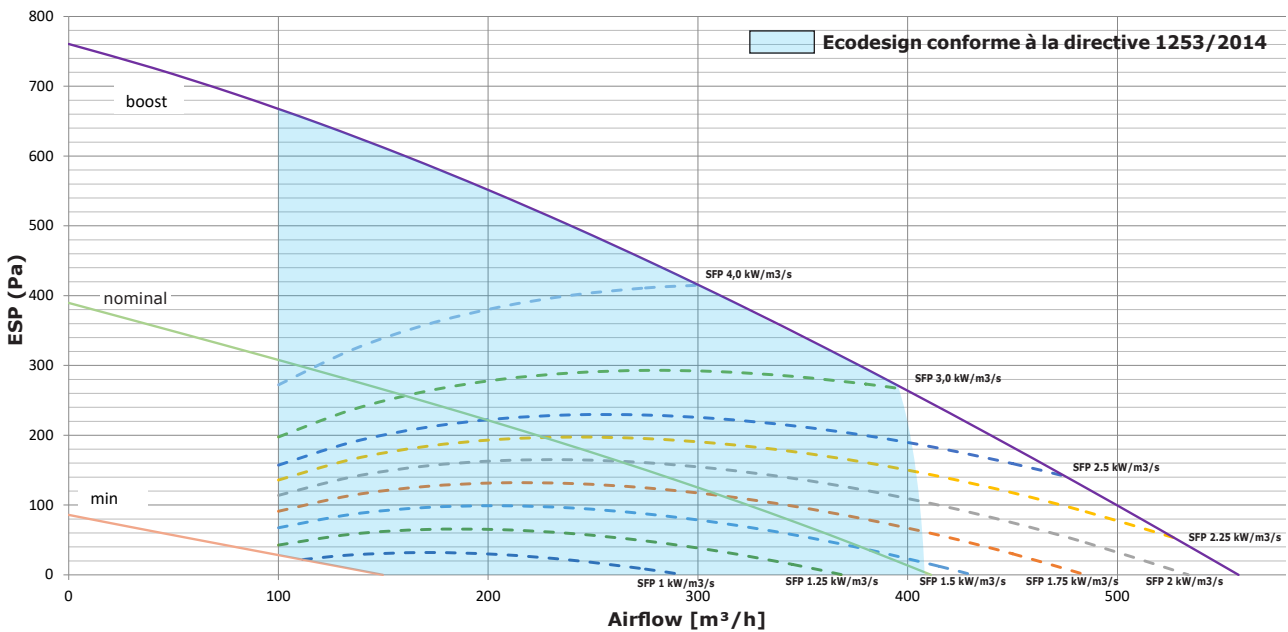

HRWA3-700

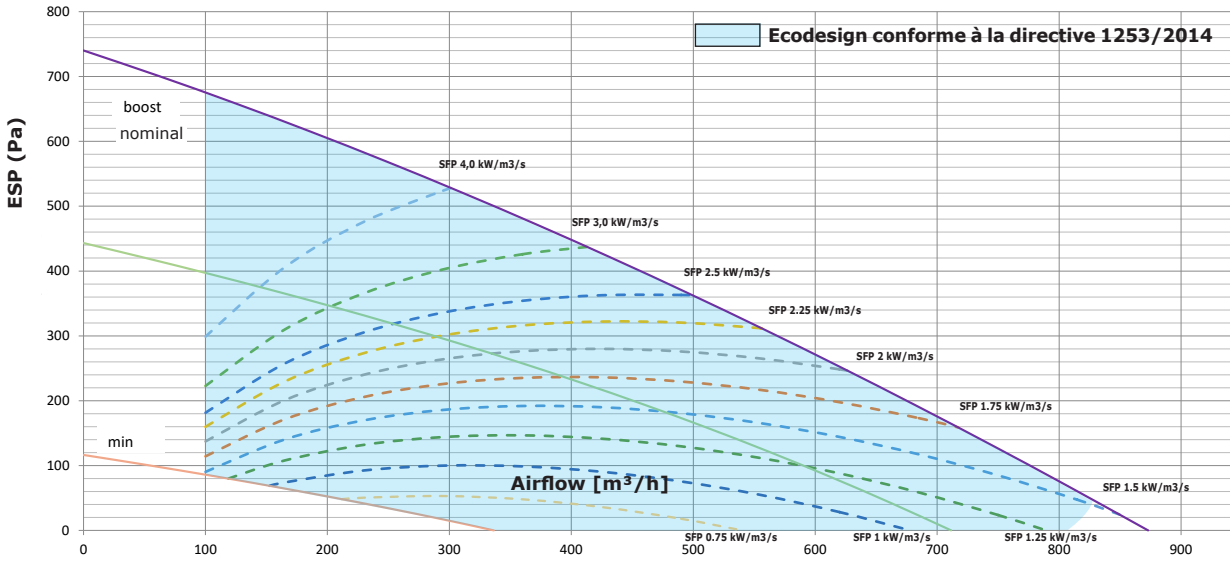

HRWA3-1000

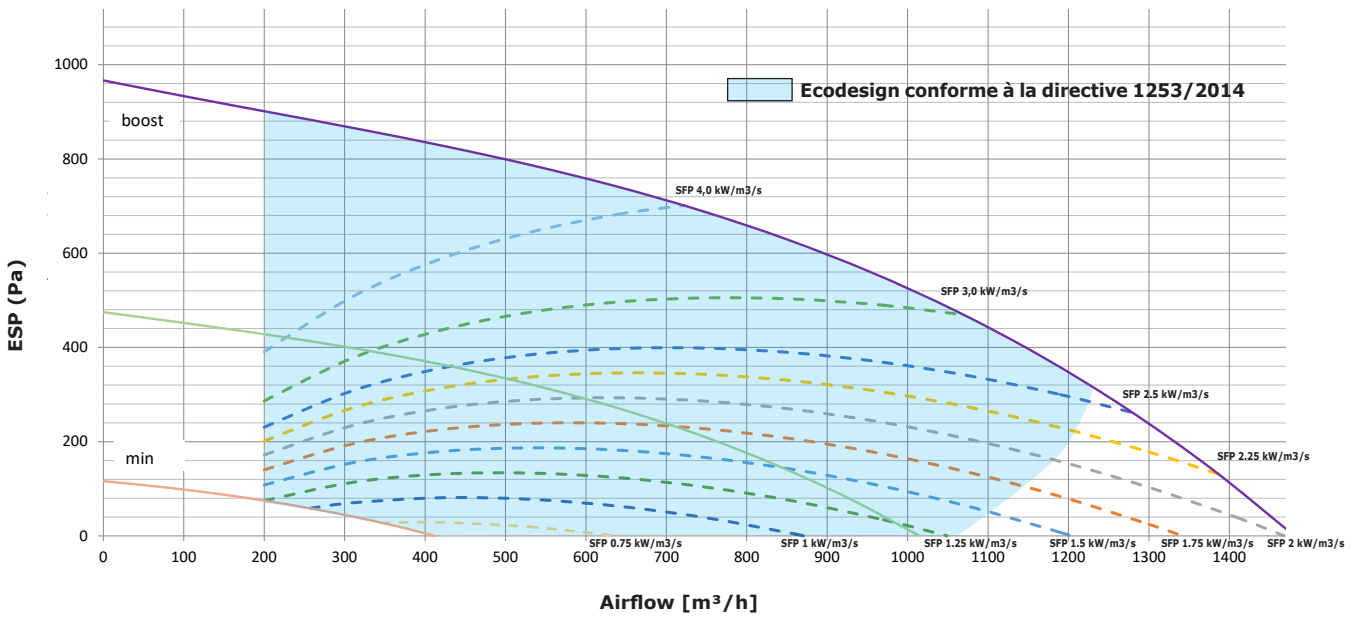



PRIMARY PARAMETERS

Heat recovery efficiency:

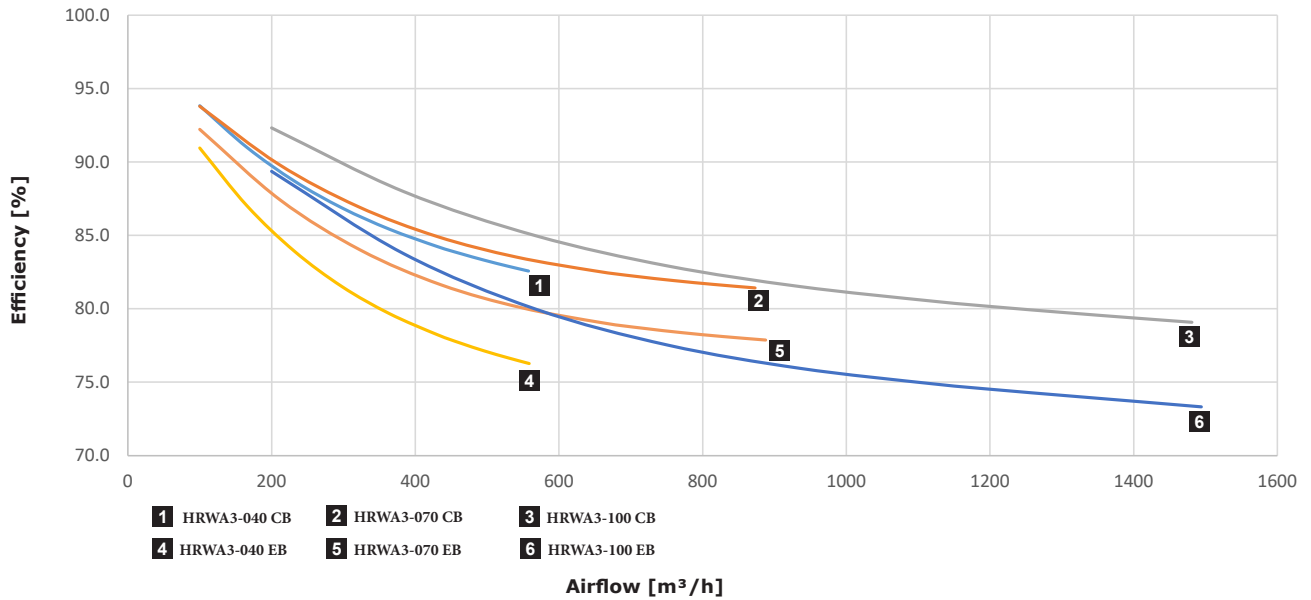

The data is measured under following conditions (EN308):
 Outdoor air temperature is +5°C, relative humidity 72%
 Indoor air temperature is +25°C, relative humidity 28%

Humidity recovery efficiency:

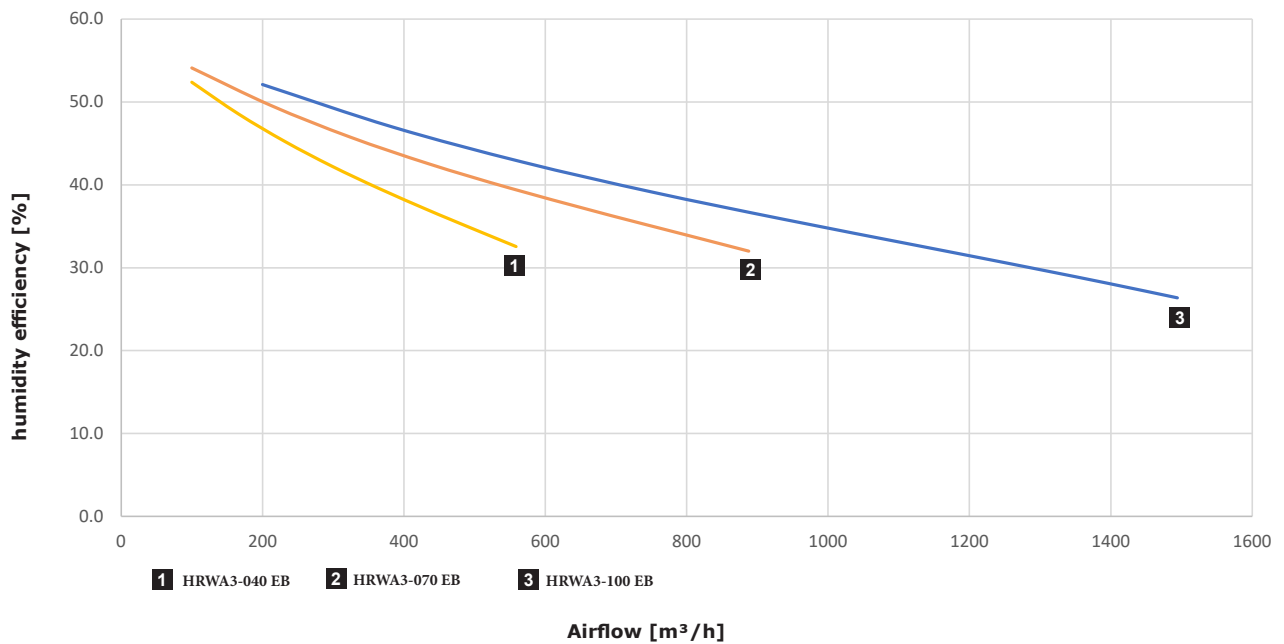

The data is measured under following conditions (EN308):
 Outdoor air temperature is +5°C, relative humidity 72%
 Indoor air temperature is +25°C, relative humidity 28%

Air Reach:

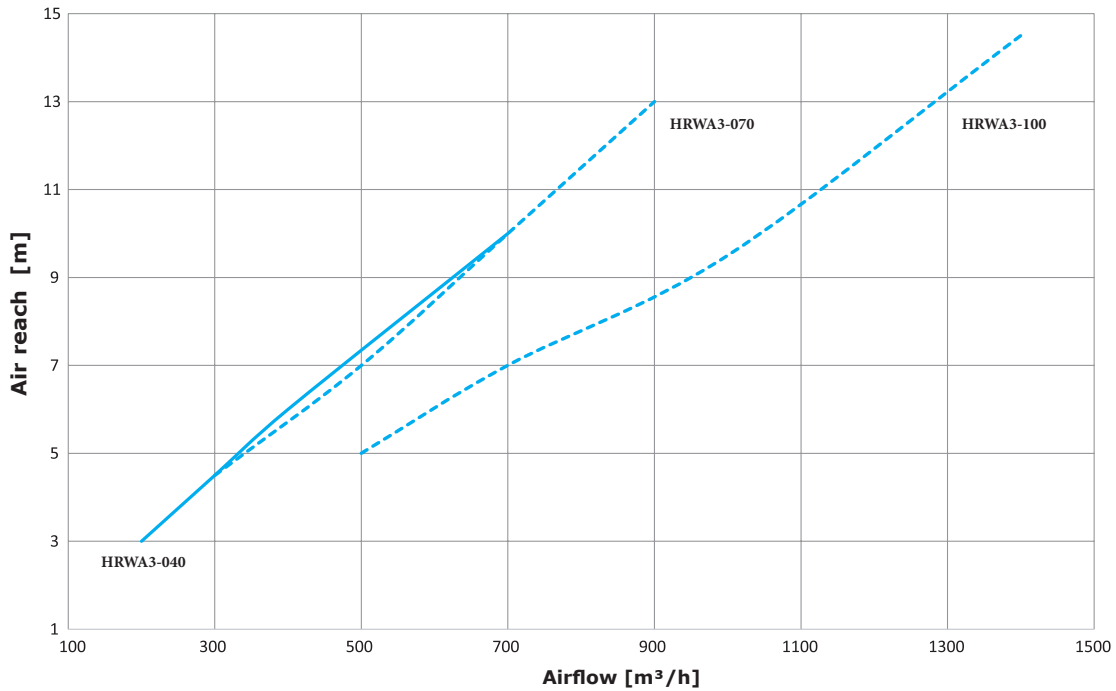

PRIMARY PARAMETERS

Noise specifications:

HRWA3-040 (casing radiated sound power level)

Fan speed	Pressure [Pa]	Airflow [m³/h]	Sound power level per frequency band								Overall		
			63Hz	125Hz	250Hz	500Hz	1kHz	2kHz	4kHz	8kHz	L _{WA} [dB]	L _{PA} [dB] ¹⁾	L _{PA} [dB] ²⁾
min	10	100	52	53	37	24	17	12	15	18	38	25	18
nominal	10	400	64	58	52	40	36	32	21	21	47	35	28
Boost	10	500	70	62	56	45	41	37	25	25	52	39	32

- 1) Sound pressure levels calculated at 1 meter for Q=4
- 2) Sound pressure levels calculated at 3 meters for Q=4

HRWA3-040 (sound power level in exhaust air duct)

Fan speed	Pressure [Pa]	Airflow [m³/h]	Sound power level per frequency band								Overall
			63Hz	125Hz	250Hz	500Hz	1kHz	2kHz	4kHz	8kHz	L _{WA} [dB]
min	10	100	65	63	52	40	30	27	12	3	49
nominal	10	400	73	71	70	56	50	51	43	43	64
Boost	10	500	78	74	75	61	54	57	49	51	69

HRWA3-040 (sound power level in fresh air duct)

Fan speed	Pressure [Pa]	Airflow [m³/h]	Sound power level per frequency band								Overall
			63Hz	125Hz	250Hz	500Hz	1kHz	2kHz	4kHz	8kHz	L _{WA} [dB]
min	10	100	67	63	51	36	28	20	14	1	49
nominal	10	400	74	70	68	55	49	44	40	40	62
Boost	10	500	79	73	71	59	53	49	46	46	65

HRWA3-070 (casing radiated sound power level)

Fan speed	Pressure [Pa]	Airflow [m³/h]	Sound power level per frequency band								Overall		
			63Hz	125Hz	250Hz	500Hz	1kHz	2kHz	4kHz	8kHz	L _{WA} [dB]	L _{PA} [dB] ¹⁾	L _{PA} [dB] ²⁾
min	10	300	49	52	38	24	18	12	10	13	37	24	17
nominal	10	700	62	57	50	41	38	33	23	20	47	33	27
Boost	10	800	64	58	51	43	41	37	25	20	49	35	29

- 1) Sound pressure levels calculated at 1 meter for Q=4
- 2) Sound pressure levels calculated at 3 meters for Q=4

HRWA3-070 (sound power level in exhaust air duct)

Fan speed	Pressure [Pa]	Airflow [m³/h]	Sound power level per frequency band								Overall
			63Hz	125Hz	250Hz	500Hz	1kHz	2kHz	4kHz	8kHz	L _{WA} [dB]
min	10	300	59	64	51	44	37	32	24	19	50
nominal	10	700	71	71	70	55	52	53	45	50	64
Boost	10	800	73	73	73	57	54	56	48	53	67

HRWA3-070 (sound power level in fresh air duct)

Fan speed	Pressure [Pa]	Airflow [m³/h]	Sound power level per frequency band								Overall
			63Hz	125Hz	250Hz	500Hz	1kHz	2kHz	4kHz	8kHz	L _{WA} [dB]
min	10	300	59	60	49	38	32	26	17	14	46
nominal	10	700	70	67	64	52	49	47	42	42	59
Boost	10	800	73	69	66	54	51	50	46	47	61

HRWA3-100 (casing radiated sound power level)

Fan speed	Pressure [Pa]	Airflow [m³/h]	Sound power level per frequency band								Overall		
			63Hz	125Hz	250Hz	500Hz	1kHz	2kHz	4kHz	8kHz	L _{WA} [dB]	L _{PA} [dB] ¹⁾	L _{PA} [dB] ²⁾
min	10	400	53	53	38	28	22	18	17	17	38	24	18
nominal	10	1000	65	60	52	42	37	36	29	24	48	34	28
Boost	10	1400	77	66	57	49	45	42	36	33	56	42	36

- 1) Sound pressure levels calculated at 1 meter for Q=4
- 2) Sound pressure levels calculated at 3 meters for Q=4

HRWA3-100 (sound power level in exhaust air duct)

Fan speed	Pressure [Pa]	Airflow [m³/h]	Sound power level per frequency band								Overall
			63Hz	125Hz	250Hz	500Hz	1kHz	2kHz	4kHz	8kHz	L _{WA} [dB]
min	10	400	60	64	47	38	41	38	30	21	50
nominal	10	1000	74	69	66	54	56	59	54	53	65
Boost	10	1400	80	76	70	61	63	64	62	63	71

HRWA3-100 (sound power level in fresh air duct)

Fan speed	Pressure [Pa]	Airflow [m³/h]	Sound power level per frequency band								Overall
			63Hz	125Hz	250Hz	500Hz	1kHz	2kHz	4kHz	8kHz	L _{WA} [dB]
min	10	400	61	61	50	39	39	40	31	24	49
nominal	10	1000	71	68	62	52	56	55	54	48	62
Boost	10	1400	80	75	66	58	62	62	59	60	69

Basic technical parameters of the heat recovery units:

Model without preheater and afterheater

Type	Phase [pcs]	Voltage [V]	Frequency [Hz]	Total consumption [W]	Total current [A]	Weight [kg]	Weight [kg] Top connection
HRWA3-040..-XS0...	1	230	50	350	2,5	167	172
HRWA3-070..-XS0...	1	230	50	350	2,5	200	206
HRWA3-100..-XS0...	1	230	50	900	4,0	267	274



Attention:

Models without preheater are suitable for outside air not lower than -5°C. In situations lower than -5°C unit will work in antifreeze mode and could shut down to prevent damage of internal components. We recommend installation should be designed by an HVAC professional.

Model with electric preheater only

Type	Phase [pcs]	Voltage [V]	Frequency [Hz]	Total consumption [W]	Total current [A]	Weight [kg]	Weight [kg] Top connection
HRWA3-040..-ES0...	1	230	50	1850	9,0	168	173
HRWA3-070..-ES0...	1	230	50	2350	11,2	201	207
HRWA3-100..-ES0...	3	400	50	3900	7,5	268	275
HRWA3-100..-GS0...	1	230	50	2900	12,7	270	277

Model with electric afterheater only

Type	Phase [pcs]	Voltage [V]	Frequency [Hz]	Total consumption [W]	Total current [A]	Weight [kg]	Weight [kg] Top connection
HRWA3-040..-XE1...	1	230	50	1850	9,0	169	174
HRWA3-070..-XE1...	1	230	50	2600	12,3	202	208
HRWA3-100..-XE1...	3	400	50	3900	8,3	270	277
HRWA3-100..-XE0...	1	230	50	2900	12,7	270	277

Model with water afterheater only

Type	Phase [pcs]	Voltage [V]	Frequency [Hz]	Total consumption [W]	Total current [A]	Weight [kg]	Weight [kg] Top connection
HRWA3-040..-XV1...	1	230	50	350	2,5	169	174
HRWA3-070..-XV1...	1	230	50	350	2,5	201	207
HRWA3-100..-XV1...	1	230	50	900	4,0	270	277

Model with electric preheater and electric afterheater

Type	Phase [pcs]	Voltage [V]	Frequency [Hz]	Total consumption [W]	Total current [A]	Weight [kg]	Weight [kg] Top connection
HRWA3-040..-EE1...	1	230	50	3350	15,5	170	175
HRWA3-070..-EE1...	3	400	50	4600	9,8	203	209
HRWA3-100..-EE1...	3	400	50	6900	12,7	270	277

Model with electric preheater and water afterheater

Type	Phase [pcs]	Voltage [V]	Frequency [Hz]	Total consumption [W]	Total current [A]	Weight [kg]	Weight [kg] Top connection
HRWA3-040..-EV1...	1	230	50	1850	9,0	170	175
HRWA3-070..-EV1...	1	230	50	2350	11,2	203	209
HRWA3-100..-EV1...	3	400	50	3900	7,5	270	277
HRWA3-100..-GV1...	1	230	50	2900	12,7	270	277

Characteristics of electric motor (1 fan only)

Type	Phase [pcs]	Voltage [V]	Frequency [Hz]	Total consumption [W]	Total current [A]	Speed [r/min]	Protection IP	Insulation class
HRWA3-040	1	230	50	170	1,2	2550	54	B
HRWA3-070	1	230	50	170	1,2	2550	54	B
HRWA3-100	1	230	50	280	1,3	3350	54	B

Characteristics of electric preheater

Type	Phase [pcs]	Voltage [V]	Frequency [Hz]	Total consumption [W]	Total current [A]
HRWA3-040..-ES0...	1	230	50	1500	6,6
HRWA3-070..-ES0...	1	230	50	2000	8,7
HRWA3-100..-ES0...	3	400	50	3000	4,3
HRWA3-100..-GS0...	1	230	50	2000	8,7

Characteristics of electric afterheater

Type	Phase [pcs]	Voltage [V]	Frequency [Hz]	Total consumption [W]	Total current [A]
HRWA3-040..-XE1...	1	230	50	1500	6,6
HRWA3-070..-XE1...	1	230	50	2250	9,8
HRWA3-100..-XE1...	3	400	50	3000	4,3
HRWA3-100..-XE0...	1	230	50	2000	8,7

Characteristics of water heating coil

For water temperature gradient 90/70 and inlet air temperature 10°C

Type	Rated input [kW]	Water pressure loss [kPa]	Air pressure loss [Pa]	Water flow [m³/h]	Connection diameter
HRWA3-040	4,9	10,6	8	0,22	G3/4"
HRWA3-070	6,3	17,0	21	0,29	G3/4"
HRWA3-100	9,3	10,4	16	0,46	G3/4"

Recommended K_v for different temperature gradients

Correction coefficients of the powers of the hot water coil*						
Air inlet temperature [°C]	Water temperature gradient					
	90/70	85/65	80/60	75/55	70/50	65/45
0	1,14	1,06	0,98	0,90	0,82	0,74
5	1,07	0,99	0,91	0,83	0,75	0,67
10	1,00	0,92	0,84	0,76	0,67	0,59
15	0,93	0,85	0,76	0,68	0,60	0,52
20	0,85	0,77	0,69	0,61	0,53	0,44

* To apply to the rated power in the characteristics of the hot water coil.

Characteristics of change-over coil (C/O)

For water temperature gradient 60/40 and inlet air temperature 10°C

Type	Rated input [kW]	Water pressure loss [kPa]	Air pressure loss [Pa]	Water flow [m³/h]	Connection diameter
HRWA3-040	4,2	0,5	19	0,19	G3/4"
HRWA3-070	6,3	1,1	47	0,28	G3/4"
HRWA3-100	10,1	3,0	40	0,45	G3/4"

Correction coefficients of the powers of the hot water coil*				
Air inlet temperature [°C]	Water temperature gradient			
	60/40	55/50	45/40	35/30
0	1,28	1,47	1,18	0,88
5	1,14	1,33	1,04	0,74
10	1,00	1,19	0,90	0,60
15	0,85	1,05	0,76	0,46
20	0,67	0,91	0,61	0,31

* To apply to the rated power in the characteristics of the C/O coil.

For water temperature gradient 7/12, inlet air temperature 25°C and RH 70%

Type	Rated input [kW]	Water pressure loss [kPa]	Air pressure loss [Pa]	Water flow [m ³ /h]	Connection diameter
HRWA3-040	2,5	2,8	28	0,42	G3/4"
HRWA3-070	3,7	5,8	67	0,64	G3/4"
HRWA3-100	6,3	19,2	58	1,08	G3/4"

Correction coefficients of the powers of the hot water coil*			
Air inlet temperature [°C]	Water temperature gradient		
	7/12	6/11	5/10
25°C	1,00	1,10	1,20
24°C	0,86	0,98	1,08
28°C	1,39	1,49	1,60
32°C	1,97	2,08	2,18

* To apply to the rated power in the characteristics of the C/O coil.

Recommended K_{vs} for different temperature gradients

Water heating coil

Type	Inlet/outlet temperature of water [°C]"	K_{vs} [flow / kPa]	Water flow [m ³ /h]	Recommended pump head [m]
HRWA3-040	90/70	0,63	0,22	2,4
	80/60	0,63	0,18	1,7
	70/50	0,63	0,15	1,2
	60/40	0,63	0,11	0,7
HRWA3-070	90/70	01,0	0,28	2,7
	80/60	01,0	0,23	1,9
	70/50	0,63	0,19	1,9
	60/40	0,63	0,14	1,1
HRWA3-100	90/70	01,6	0,41	2,2
	80/60	01,0	0,34	2,2
	70/50	01,0	0,26	1,3
	60/40	0,63	0,19	1,3

Water cooling / heating coil

Type	Heating - water temperature gradient	K_{vs} [flow / kPa]	Cooling - water temperature gradient					
			7/12		6/11		5/10	
			Water flow [m ³ /h]	Recommended pump head [m]	Water flow [m ³ /h]	Recommended pump head [m]	Water flow [m ³ /h]	Recommended pump head [m]
HRWA3-040	60/40	0,63	0,42	4,52	0,48	5,88	0,53	7,16
	55/50	01,6	0,86	3,85	0,86	3,85	0,86	3,85
	45/40	01,6	0,65	2,23	0,65	2,23	0,65	2,23
	35/30	01,6	0,44	1,04	0,48	1,19	0,53	1,39
HRWA3-070	90/70	01,0	0,64	4,26	0,70	5,07	0,76	5,96
	80/60	02,5	1,32	4,94	1,32	4,94	1,32	4,94
	70/50	02,5	0,99	2,85	0,99	2,85	0,99	2,85
	60/40	02,5	0,66	1,31	0,70	1,41	0,76	1,56
HRWA3-100	90/70	01,6	1,08	5,01	1,18	5,92	1,28	6,91
	80/60	04,0	1,97	7,79	1,97	7,79	1,97	7,79
	70/50	04,0	1,49	4,64	1,49	4,64	1,49	4,64
	60/40	04,0	1,08	2,37	1,18	2,54	1,28	2,73



INSTALLATION AND ASSEMBLY

The unit must be installed in such a way that the direction of the air blown corresponds to the direction of air circulation. The unit must be installed so as to give free access for maintenance, service or dismantling. This is to allow access to service flaps and possibility to open them, access to the lid of the control panel, access to the lateral connections and access to the filter cover.

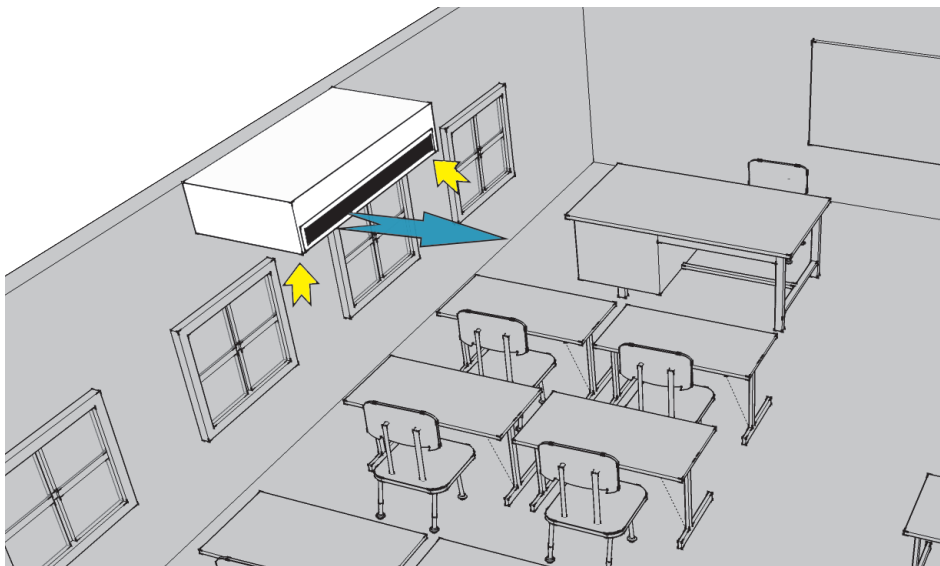
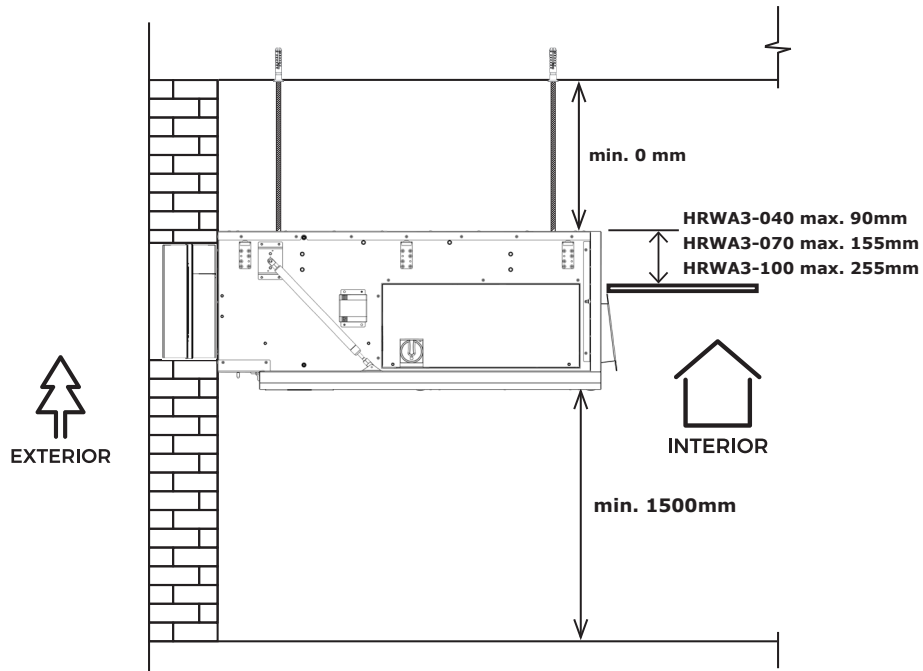



DIMENSIONS

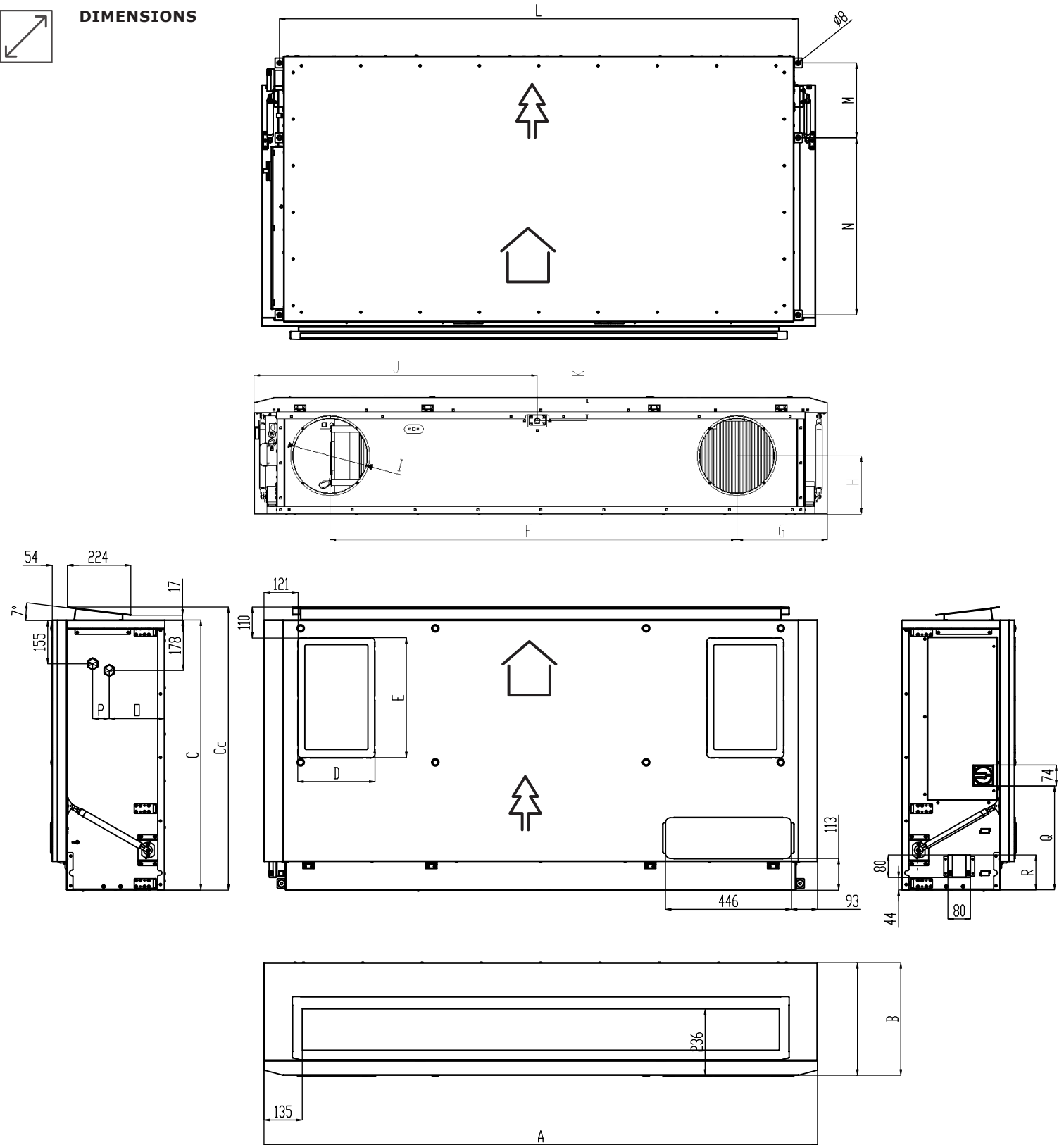

[mm]																			
Type	A	B	C	Cc	D	E	F	G	H	I	J	K	L	M	N	O	P	Q	R
HRWA3-040	1960	399	957	1003	274	425	1390	310	199	255	968	79	1836	265	627	197	59	370	124
HRWA3-070	2230	459	1113	1159	285	452	1650	290	225	320	1083	79	2106	469	469	231	69	522	433
HRWA3-100	2553	576	1280	1326	410	542	1920	317	289	320	1277	79	2430	519	519	313	69	691	543



DIMENSIONS

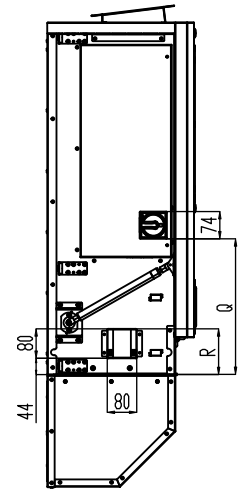
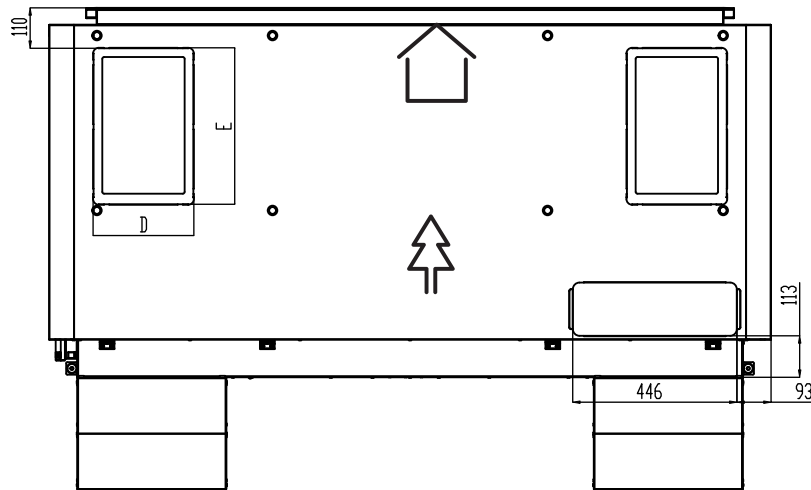
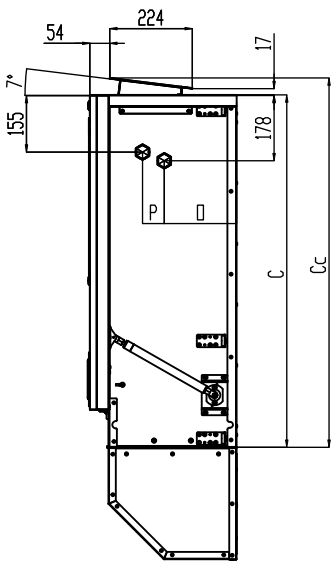
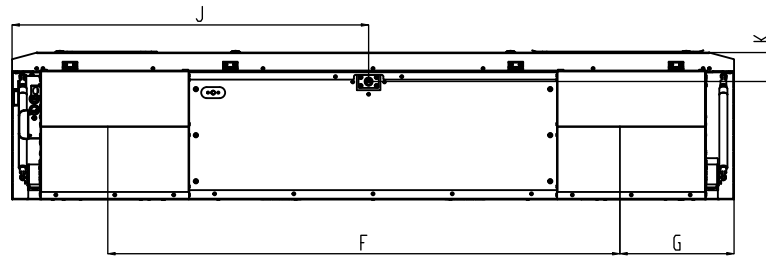
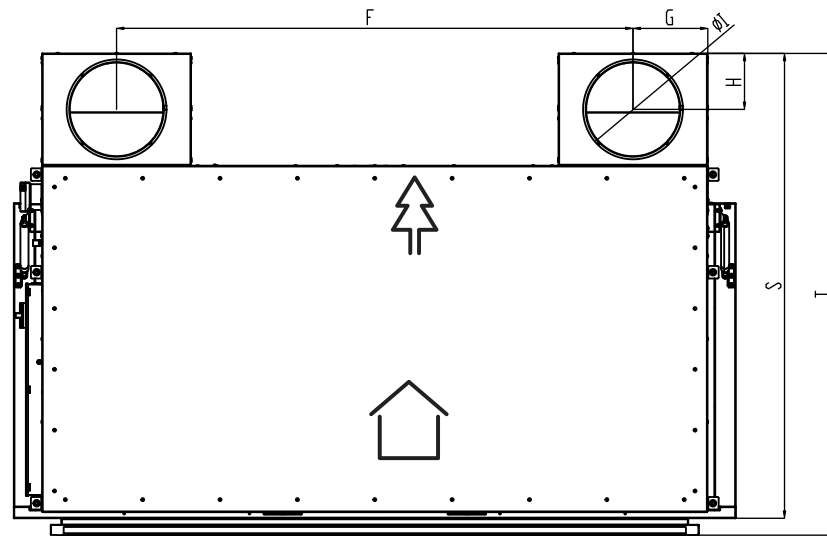

[mm]																					
Type	A	B	C	Cc	D	E	F	G	H	I	J	K	L	M	N	O	P	Q	R	S	T
HRWA3-040	1960	399	957	1003	274	425	1402	202	152	255	968	79	1836	265	627	197	59	370	124	1262	1308
HRWA3-070	2230	459	1113	1159	285	452	1826	202	188	320	1083	79	2106	469	469	231	69	522	433	1490	1536
HRWA3-100	2553	576	1280	1326	410	542	2100	227	188	320	1277	79	2430	519	519	313	69	691	543	1655	1700



CONTROL

AirGENIO SUPERIOR - Main control functions



- Touch control
- Stepless fans (0-10V)
- Stepless afterheating (internal Electrical: SSR)
- Stepless automatic control of preheating
- Integrated timer (daily, weekly)
- Optional connection of sensors: CO2, RH, VOC (0-10)
- Stepless Bypass (temperature control: freecooling, antifreeze protection)
- Offset fan adjustment (over-pressure and underpressure)
- Indication of filter clogging
- CAV or DCV ventilation mode
- BOOST function - intensive airflow (nominal airflow +25%) for a set period
- Freecooling functions - night ventilation (cooling)
- Occupancy functions - reducing ventilation according to the PIR sensor
- BMS - connection via Modbus RTU / TCP, BACnet

2VW AirGENIO Application:

- Product control on your smartphone
- Info about operation status
- Notifications – request for service, filter exchange, error status, etc.
- Download the 2VW AirGENIO APP and control it remotely from your smart phone!



2VW Service software:

- Easy and quick commissioning from your computer
- Error log – error display and identification
- Easy service (device status loading/reset to backup setting)
- Fast FW update
- OFFLINE version





WIRING DIAGRAMS

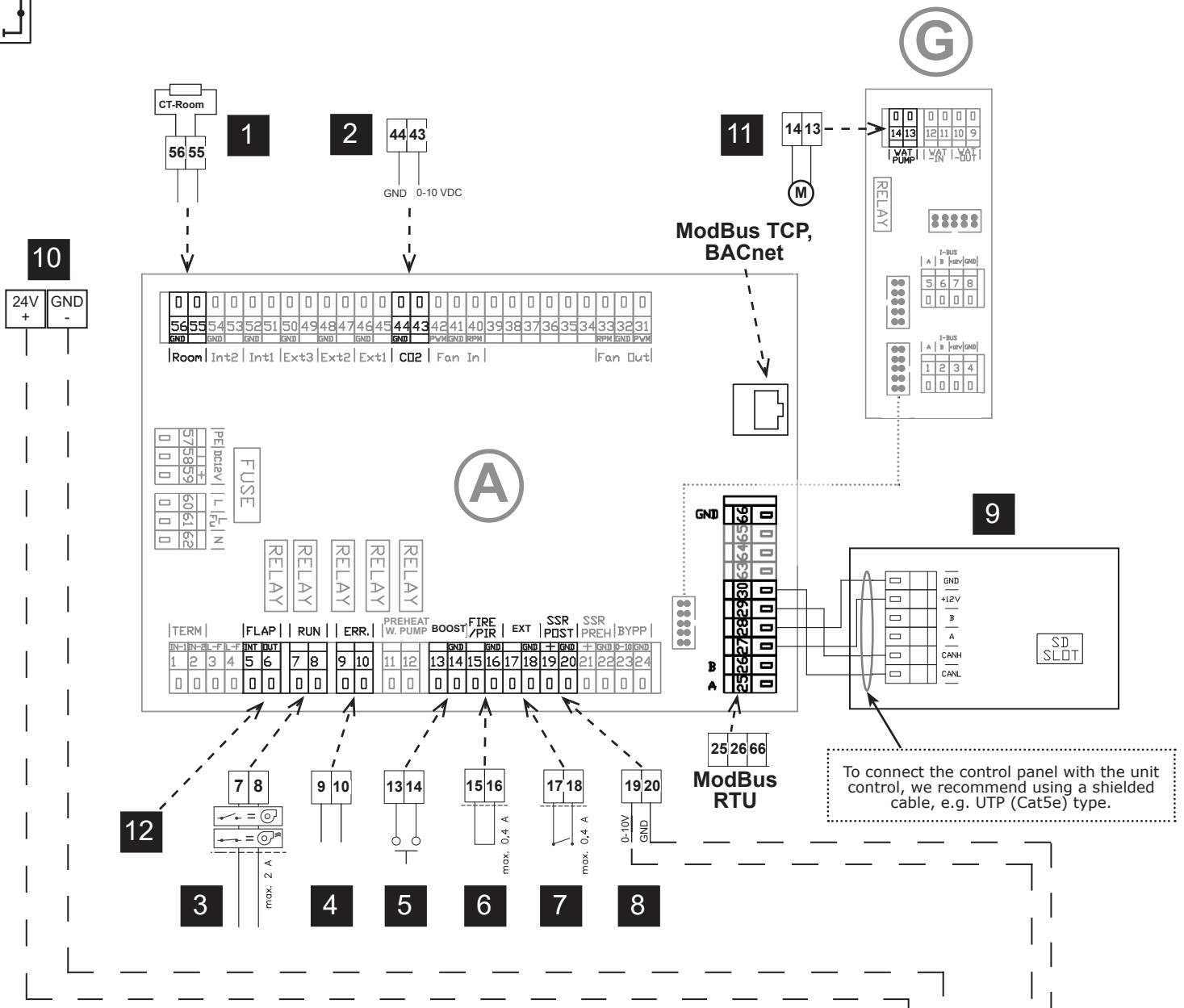

To connect the control panel with the unit control, we recommend using a shielded cable, e.g. UTP (Cat5e) type.

1	Room temperature sensor (input)
2	The air quality sensor - control signal (input)
3	RUN contact (relay contact)
4	ERROR contact (relay contact)
5	BOOST regime (input)
6	Alarm - FIRE (input) or PIR (input)
7	External control - ON/OFF
8	SMU control signal (0-10V, output)
9	Control panel
10	24V power supply for SMU (output)
11	Water pump (relay contact, max. 2A)
12	Air dampers (230V output - air IN/OUT)

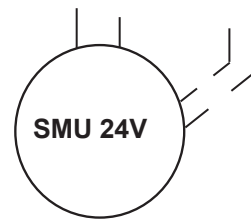



ACCESSORIES

RECOMMENDED ACCESSORIES

Filter replacement

Spare filters classes and configurations.



Unit type	Standard		Option	
	Filter Coarse 65% *	Filter ePM1 60%	Filter ePM10 50% *	Filter ePM1 80%
HRWA3-040	HRWA3-040H-FI-G4-0A0	HRWA3-040H-FI-F7-0A0	HRWA3-040H-FI-M5-0A0	HRWA3-040H-FI-F9-0A0
HRWA3-070	HRWA3-070H-FI-G4-0A0	HRWA3-070H-FI-F7-0A0	HRWA3-070H-FI-M5-0A0	HRWA3-070H-FI-F9-0A0
HRWA3-100	HRWA3-100H-FI-G4-0A0	HRWA3-100H-FI-F7-0A0	HRWA3-100H-FI-M5-0A0	HRWA3-100H-FI-F9-0A0

* Set of 2pcs

Condensate siphon

SK-HL138

Siphon with a ball for installation on the wall or flush mounting.



Condensate siphon

SK-AKS3

Ball Siphon for direct connection to the unit.



Condensate pump

PUMP-012

The pump is designed to be installed in the condensate tray of the unit.

Note:

Use of pump is recommended where gravity assisted condensate collection is not achievable.

Accessory supplied loose for fitting on site.



Threaded rods

ZTZ-M8-1,0 – threaded rod, thread M8, length 1m, suitable for all types of under the ceiling type units.



Air damper with actuator KRTK-A-SB

Unit type	Air damper type
HRWA3-040	KRTK-A-250-SB
HRWA3-070	KRTK-A-315-SB
HRWA3-100	KRTK-A-315-SB



Module for connection from the top

Additional module to connect the air duct from the top.

Unit type	Module type	Module weight [kg]
HRWA3-040	HRWA3-040-UP-250-0A0	5
HRWA3-070	HRWA3-070-UP-315-0A0	6
HRWA3-100	HRWA3-100-UP-315-0A0	7

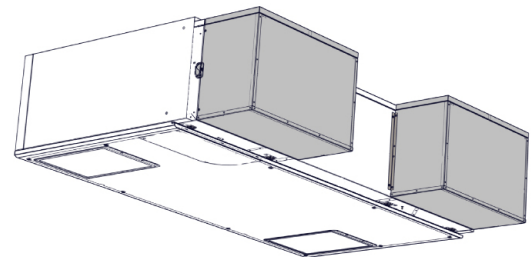

HRWA3 - 040 - UP - 250

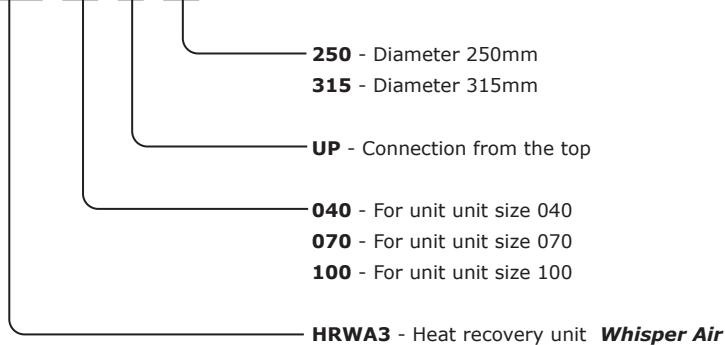

Mixing valve

The **SMU** mixing unit is designed for controlling the heat-output of water-type heat exchangers. It is used especially for controlling standalone water-type air heaters, heaters inbuilt into the ventilation units.

Recommended values for individual types of the **ALFA 95 FLAT** units:

SMU2-024-06,3-SC

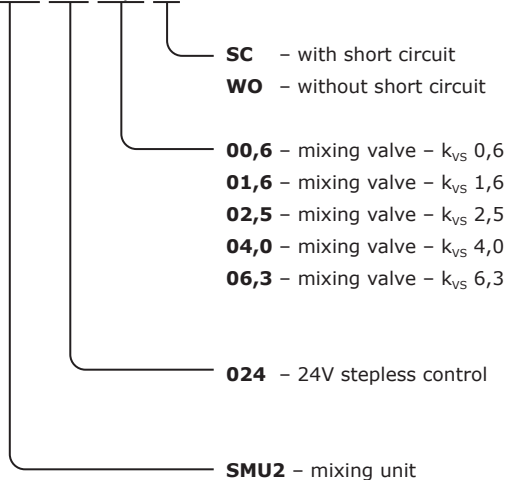

Air stream operated shutter

VK

Non-corrosive, long life, weather and ultra-violet stable polymers. Colour light grey. Easy and quick installation. Can be used as outlet shutter only.

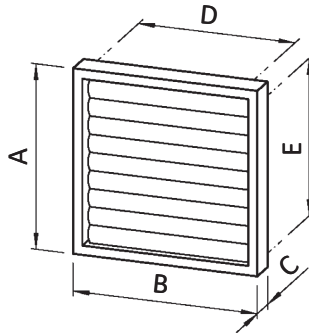

Unit type	Model	A [mm]	B [mm]	C [mm]	D [mm]	E [mm]
HRWA3-040	VK250	290	290	28	243	217
HRWA3-070	VK315	340	340	28	293	267
HRWA3-100	VK315	340	340	28	293	267

Air shutter with fixed lamelas

WFK

Non-corrosive, long life, weather and ultra-violet stable polymers. Colour light grey. Easy and quick installation. Can be used as inlet or outlet shutter.

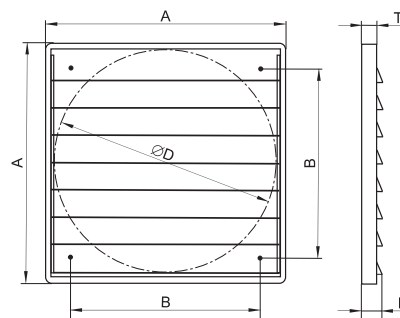

Unit type	Model	A [mm]	B [mm]	D [mm]	F [mm]	T [mm]
HRWA3-040	WFK-25-02	294	232	258	42	26
HRWA3-070	WFK-30-02	346	276	310	42	26
HRWA3-100	WFK-30-02	346	276	310	42	26



KEY TO CODING

HRWA3-070 HX CB E 74-E S0 S-0 A 0

